

A close-up photograph of the Athmer Fingerprotector NR-32 UniSafe. The device is a grey, rectangular, wedge-shaped object with a black, textured top surface. The word "ATHMER" is embossed on the black surface. It is shown against a red background.

Athmer Fingerprotector

NR-32 UniSafe®

Athmer - securely sealed.





Athmer Fingerschutz® makes doors safer!

Experience – Competence – Innovation

Every day occur unnecessary accidents with unsafe doors. With Athmer finger protection inadvertently trapping fingers between door leaf and frame can be avoided. Numerous architects, installers and building owners have relied on Athmer finger guards for years due to the additional and reliable safety like in kindergartens, schools or health care centres.

Plan and offer safety for doors with Athmer Fingerschutz® - the proven protection system for more than 30 years!.

NR-32 UniSafe® sets new standards

in design, safety & functionality

Athmer have developed the NR-32 UniSafe®, a new and universal useable finger protection system which is convincing due to its unique design, improved safety and many additional features.

One DESIGN for all applications

- ▶ appropriate integration in existing interior and door designs
- ▶ internal & external options available offering a continuous design throughout the building
- ▶ increased stability of the housing due to the special design
- ▶ easy to retrofit on most door types
- ▶ individual choice of length and colour

SAFETY in use

- ▶ more protection by covering the door gap
- ▶ protection caps defuse profile ends
- ▶ tamper-resistant CLICKsystem with concealed screws prevent from manipulation of the system e.g. by kids or young people



NR-32 UniSafe®

"Its discrete design allows integration into existing interior and door designs"



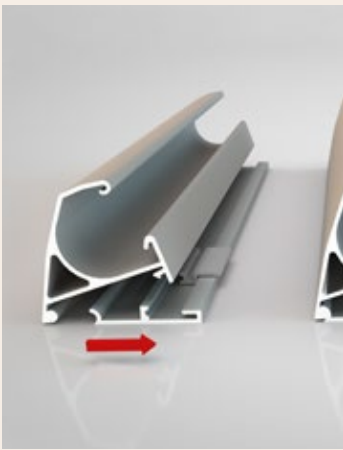

NR-32 UniSafe® – CLICK safes time and money

The new CLICKsystem offers additional options

The new CLICKsystem allows the installer to mount the finger protector very easy and gives the option to install the fixing profiles and then the main finger protector at a later date. Furthermore the system can be easily demounted to allow for servicing and cleaning issues.

CLICKsystem for a quick & safe mounting / demounting

- time- & money-saving with intelligent fixing due to less fixing points
- mounting during daily business possible
- CLICKsystem provides easy mounting and demounting with audible confirmation of a secure attachment.
- easy to replacement of a damaged finger protector
- system can be glued on glass doors

PROPERTY FIXING in 2 steps – safe commissioning guarantee

- time-shifted delivery and mounting of the fixing profiles and the finger protector prevents the product being damaged during building phase
- fixing profiles can be pre-assembled in the factory. No additional drilling on site needed *
- time-shifted mounting of the finger protection secures hand over of building site **

SERVICE and CLEANING made easy unlocking

- trouble-free service of hinges, adjustment of drop seals by maintenance personnel
- easy cleaning also of the door gap and surface wipe disinfection tested
- especially suitable for health care areas with high hygienic requirements



NR-32 UniSafe®

“Due to the new CLICKsystem mounting, service and cleaning are easily possible”



* 1. Building phase – only fixing profiles mounted



**2. Mounting of the NR-32® before building hand over



NR-32 UniSafe® – flexibility on site

Additional functionality provides added values

The possibility to adapt the system to existing hardware devices or to add an extra ram protection provides more flexibility to the planner or installer – for every requirement the perfect solution.

ADAPTATION to existing hardware simply on site

- adaptation on existing hardware devices like pushbar, touchbar or ram protection provides more flexibility on site to the installer
- a standard groove in the profile allows to notch as necessary
- standard accessories consist of screws for wooden and steel doors

RAM PROTECTION for tough environments

- ram protection element made out of stainless steel as upgrade for hospitals or airports – to avoid damage caused by hospital beds or luggage trolleys
- deflection shield as additional protection for the door and frame – especially for power operated doors
- optional available length: 500 mm, 960 mm und 1.923 mm

NR-32 UniSafe®

“Additional functionality of the NR-32 UniSafes® provides added values for installer and building owner – ideal for every requirement”



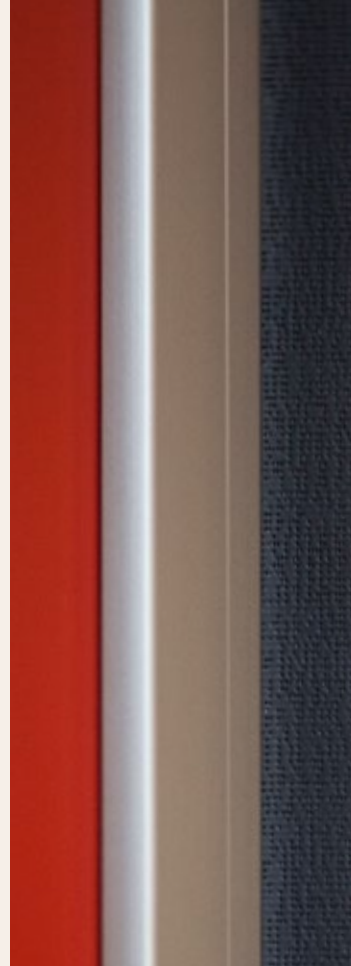

Technical data:

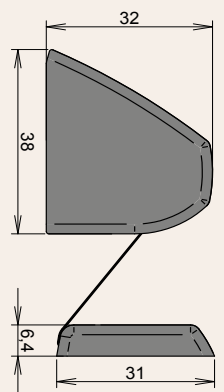

Reduction in frame
clearance dimension

Min. – Max. length

Standard length*

Length supplied for
power operated doors**

Special lengths

Can be reduced by

Ram protection – optional



NR-32 UniSafe® – Technical Information

The more of design, safety & functionality

The new NR-32 UniSafe® is easy to retrofit on most door types and can be ordered individually to any colour and lengths. The long-lasting and proved Athmer-quality is guaranteed – a premium product for more safety!

Advantages:

- One DESIGN for all applications
- SAFETY in use
- CLICKsystem, resistant, for a quick & safe mounting
- PROPERTY FIXING in 2 steps - safe commissioning guarantee
- ADAPTATION to existing hardware simply on site
- RAM PROTECTION for tough environments
- SERVICE and CLEANING due to easy unlocking
- TÜV / GS - tested following EN 16654



Mounting example:

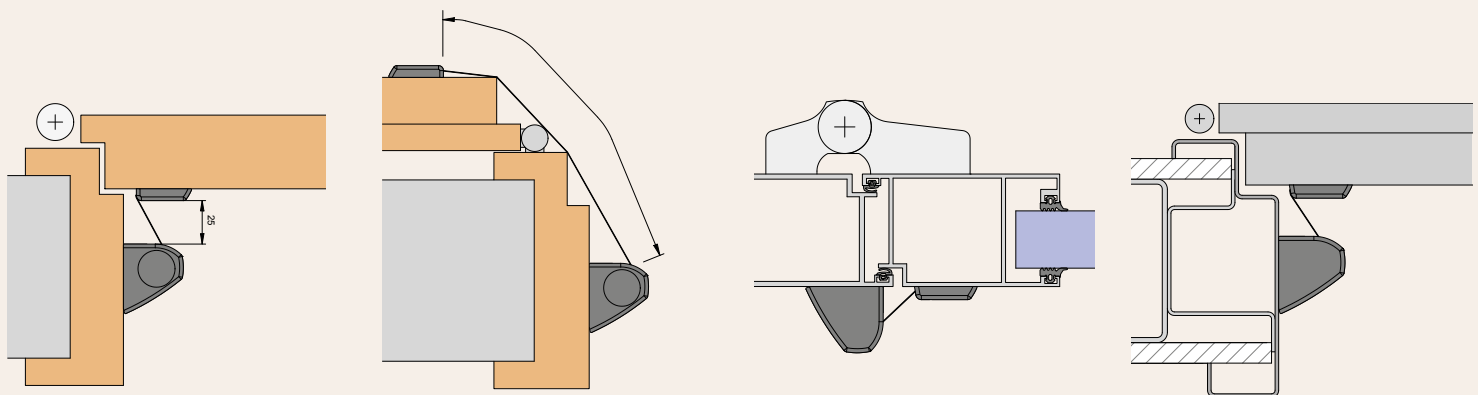

Fabric color



32 mm

325 mm - 3,000 mm

1.925 mm, 2.050 mm

2.000 mm, 2.500 mm

Available

Standard colour delivery without a surcharge

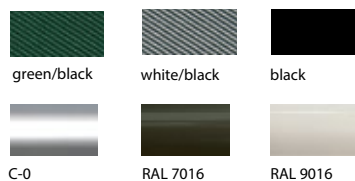

Special colour

Other colors on request.



Assembly Video

500 mm, 960 mm, 1923 mm

* Length supplied for standard doors in accordance with DIN 18101 with a basic dimension of 2000 and 2125.

**In accordance with EN 16005 - Power operated pedestrian doorsets - Safety in use

The right to make technical changes is reserved.

Athmer finger protection program

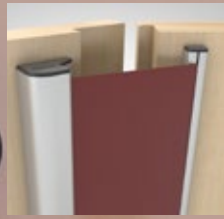

Finger Protection
(Secondary closing edge – closing face)

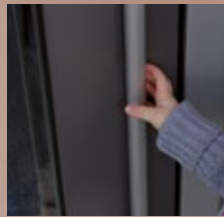

Finger Protection Profiles
(Secondary closing edge – opening face)



Finger Protection HS-25
(Main closing edge)



Avoid hazards on doors!

Execute risk assessments

During the planning process of buildings Athmer recommends to do a risk assessment on doors. All to avoid any hazardous points for possible user groups. Special requirements for vulnerable groups (children, elderly and handicapped people) should be considered in particular.

Therefore a protection of closing edges on doors should not only be done if there is a legal demand. It is the duty of the building owner to provide safe doors.

Plan and offer safety for doors with Athmer Fingerschutz®

Athmer finger protection – the reliable solution for every requirement



Nursery doors

- the German accident prevention regulations DGUV-V 82 states that “Shearing points on the hinged side of doors are to be prevented.” In other countries there are similar requirements in place
- following such regulations all the doors (internal and external doors) where children have access to have to be safe – ideal for Athmer finger protector



School doors

- the German social insurance proposes “doors have to be clearly recognised, can be safely passed and are easy to open and to close”
- in line with the inclusion or the duty of care Athmer finger protection should be used in highly frequented areas like corridors, entrances or lavatories – especially on heavy profile doors with door closes or on power operated swing doors

Doors with door closer

- to work against the draft in entrance areas or corridor doors with door closes are often installed with a higher opening torque than 3 in accordance with EN 1154
- such doors should be equipped with an Athmer finger protector due to high forces on the closing edges which could cause dangerous hazards for vulnerable groups

Power operated swing doors in accordance with EN 16005

- Power operated pedestrian doors shall be designed so that hazards due to crushing, shearing, impact and drawing-in during the opening and closing cycles are avoided
- in accordance with EN 16005 – 4.6.3.4 “Danger points between the leaf and frame presenting a fingertrap hazard shall be avoided structurally or by an appropriate protective device, e.g. finger protection, up to a height of 2.000.”



Fire-resistant doors

- Athmer finger protection systems are suitable for use with fire-resistant and smoke protection doors. The used product materials are fire-resistant or non-flammable
- numerous fire tests were successfully passed with the common door manufactures and system providers
- the door manufacturer must approve the retrofitting of the finger protection – often the finger protection is included in the general building inspectorate approval of the door
- Athmer can support in this issue

Hazardous points on doors

